

Varenummer: 0102143
 Beskrivelse: Seeger låsering J 190 DIN 472
 Fjederstål

Mål

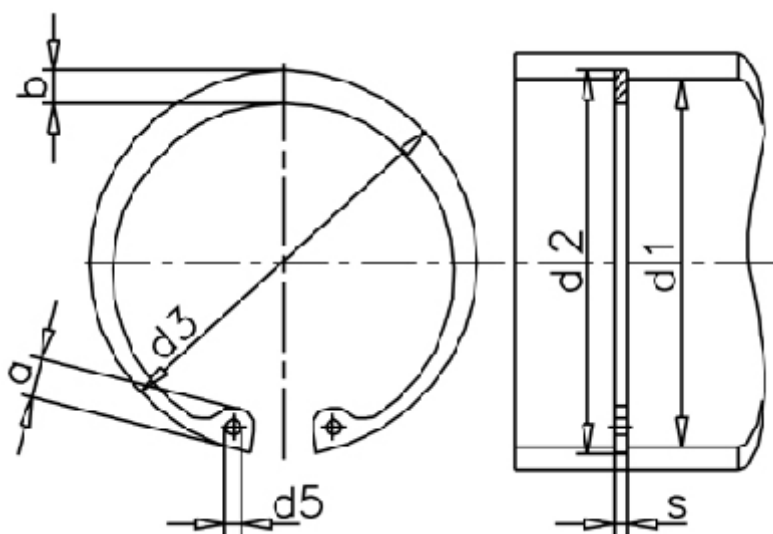

a max	= 14,2	FN kN	= 251.00	t	= 2.50
AN mm ²	= 1510.0	FRg kN	= 57.5	Tang	= ZGJ-5
b	= 13.8	FR kN	= 340.0	tol	= -0.10
Betegnelse	= J 190	g	= 3.5	tol	= +1,70-0,72
d1	= 190	K kN-mm	= 779.0	tol	= +0,72
d2	= 195.0	m min	= 4.15	vægt kg/1000	= 175.00
d3	= 199.50	Nominel træk	= 7.5		
d5 min	= 4.0	s	= 4.00		